

Nano

INSTRUCTION MANUAL



BERETTA

500 YEARS. ONE PASSION.

ALWAYS KEEP THIS MANUAL WITH YOUR FIREARM. INCLUDE IT WITH THE PISTOL WHEN IT CHANGES OWNERSHIP OR WHEN IT IS LOANED OR PRESENTED TO ANOTHER PERSON.

CAUTION: The Manufacturer and/or its Local Official Distributors assume no responsibility for product malfunction or for physical injury or property damage resulting in whole or in part from criminal or negligent use of the product, improper or careless handling, unauthorized modifications, use of defective, improper, hand-loaded, reloaded or remanufactured ammunition*, customer abuse or neglect of the product, or other influences beyond manufacturer's direct and immediate control.
* See paragraph "Ammunition".



WARNING: Always ensure that the safety is full engaged (if present) until ready to fire. A safety, which is not fully engaged, will not prevent firearm discharge.



WARNING: ALL FIREARMS HAVE LETHAL POTENTIAL. READ THE BASIC SAFETY RULES CAREFULLY AND UNDERSTAND THEM FULLY BEFORE ATTEMPTING TO USE THIS FIREARM.

In addition to the Basic Safety Rules, there are other Safety Rules pertaining to the loading, unloading, disassembly, assembly and use of this firearm, located throughout this manual.



WARNING: READ THE ENTIRE MANUAL CAREFULLY BEFORE USING THIS FIREARM. MAKE SURE THAT ANY PERSON USING OR HAVING ACCESS TO THIS FIREARM READS AND UNDERSTANDS ALL OF THIS MANUAL PRIOR TO USE OR ACCESS.

WE RECOMMEND THE USE OF ORIGINAL BERETTA SPARE PARTS AND ACCESSORIES. THE USE OF OTHER MANUFACTURER'S SPARE PARTS AND ACCESSORIES COULD CAUSE MALFUNCTIONS AND/OR BREAKAGES THAT WILL NOT BE COVERED BY THE BERETTA WARRANTY.

CONTENTS

BASIC SAFETY RULES	6-11
AMMUNITION	12-13
• Amunition	12
• Dry Firing / "Dummy" Rounds	13
LOADING AND FIRING	14-19
• Loading the Magazine and Pistol	14-15
• Unloading the Pistol and Magazine	15-17
• Firing	17-19
FEATURES & OPERATION	20-48
• Safety Features	20-22
• Operational Features	22-24
• Specifications	25
• General Operation	26-28
• Field Stripping	28-30
• Re-Assembly	31-32
• Barrel Obstruction Check	33
• Replacing the Magazine Release Button	34-36
• Reversing the Magazine Release Button	37
• Grip Frame Removal	38-42
• Grip Frame/Chassis Assembly	43-48
Maintenance & Storage	49-51
• Maintenance & Storage	49-50
• Addendum	51
TROUBLESHOOTING	52
DIAGRAM & PARTS LIST	54-55

BASIC SAFETY RULES



WARNING: PLEASE READ THIS MANUAL BEFORE HANDLING YOUR FIREARM.



WARNING: FIREARMS CAN BE DANGEROUS AND CAN POTENTIALLY CAUSE SERIOUS INJURY, DAMAGE TO PROPERTY OR DEATH, IF HANDLED IMPROPERLY. THE FOLLOWING SAFETY RULES ARE AN IMPORTANT REMINDER THAT FIREARM SAFETY IS YOUR RESPONSIBILITY.

1. NEVER POINT A FIREARM AT SOMETHING THAT IS NOT SAFE TO SHOOT.

Never let the muzzle of a firearm point at any part of your body or at another person. This is especially important when loading or unloading the firearm. When you are shooting at a target, know what is behind it. Some bullets can travel over a mile. If you miss your target or if the bullet penetrates the target, it is your responsibility to ensure that the shot does not cause unintended injury or damage.



2. ALWAYS TREAT A FIREARM AS IF IT WERE LOADED.

Never assume that a firearm is unloaded. **The only certain way to ensure that a firearm has the chamber(s) empty is to open the chamber and visually and physically examine the inside to see if a round is present.**

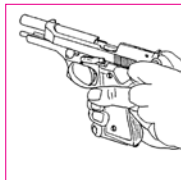

Removing or unloading the magazine will not guarantee that a firearm is unloaded or cannot fire. Firearms can be checked by cycling or removing all rounds and by then opening and inspecting the chamber so that a visual inspection of the chamber for any remaining rounds can be made.

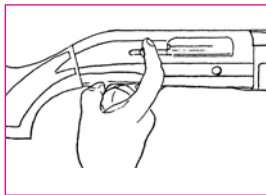
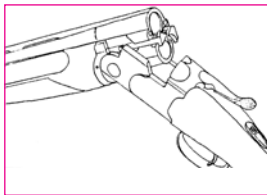

3. STORE YOUR FIREARM SO THAT CHILDREN CANNOT GAIN ACCESS TO IT.

It is your responsibility to ensure that children under the age of 18 or other unauthorized persons do not gain access to your firearm. To reduce the risk of accidents involving children, unload your firearm, lock it and store the ammunition in a separate locked location. Please note that devices intended to prevent accidents - for example, cable locks, chamber plugs, etc. - may not prevent use or misuse of your firearm by a determined person. Firearm storage in a steel gun safe may be more appropriate to reduce the likelihood of intentional misuse of a firearm by an unauthorized child or person.

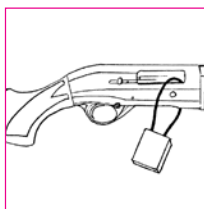

4. NEVER SHOOT AT WATER OR AT A HARD SURFACE.

Shooting at the surface of water or at a rock or other hard surface increases the chance of ricochets or fragmentation of the bullet or shot, which can result in the projectile striking an unintended or peripheral target.



5. KNOW THE SAFETY FEATURES OF THE FIREARM YOU ARE USING, BUT REMEMBER: SAFETY DEVICES ARE NOT A SUBSTITUTE FOR SAFE HANDLING PROCEDURES.

Never rely solely on a safety device to prevent an accident. It is imperative that you know and use the safety features of the particular firearm you are handling, but accidents can best be prevented by following the safe handling procedures described in these safety rules and elsewhere in the product manual. To further familiarize yourself with the proper use of this or other firearms, take a Firearms Safety Course taught by an expert in firearms use and safety procedures.

6. PROPERLY MAINTAIN YOUR FIREARM.

Store and carry your firearm so that dirt or lint does not accumulate in the working parts. Clean and oil your firearm, following the instructions provided in this manual, after each use to prevent corrosion, damage to the barrel or accumulation of impurities which can prevent use of the gun in an emergency. Always check the bore and chamber(s) prior to loading to ensure that they are clean and free from obstructions. Firing with an obstruction in the barrel or chamber can rupture the barrel and injure you or others nearby. In the event you hear an unusual noise when shooting, stop firing immediately, engage the manual safety and



unload the firearm. Make sure the chamber and barrel are free from any obstruction, like a bullet blocked inside the barrel due to defective or improper ammunition.

7. USE PROPER AMMUNITION.

Only use factory-loaded, new ammunition manufactured to industry specifications: CIP (Europe and elsewhere), SAAMI® (U.S.A.). Be certain that each round you use is in the proper caliber or gauge and type for the particular firearm. The caliber or gauge of the firearm is clearly marked on the barrels of shotguns and on the slide or barrel of pistols. The use of reloaded or remanufactured ammunition can increase the likelihood of excessive cartridge pressures, case-head ruptures or other defects in the ammunition that can cause damage to your firearm and injury to yourself or others nearby.

8. ALWAYS WEAR PROTECTIVE GLASSES AND EARPLUGS WHEN SHOOTING.

The chance that gas, gunpowder or metal fragments will blow back and injure a shooter who is firing a gun is rare, but the injury that can be sustained in such circumstances can be severe, including the possible loss of eyesight. A shooter must always wear impact resistant shooting glasses when firing any firearm. Earplugs or other high-quality hearing protectors help reduce the chance of hearing damage from shooting.



9. NEVER CLIMB A TREE, FENCE OR OBSTRUCTION WITH A LOADED FIREARM.

Open and empty the chamber(s) of your firearm and engage the manual safety before climbing or descending a tree or before climbing a fence or jumping over a ditch or other obstruction. Never pull or push a loaded firearm toward yourself or another person. Always unload a firearm, visually and physically check to

see that the magazine, loading mechanism and chamber are unloaded, and action is open before handing it to another person. Never take a firearm from another person unless it is unloaded, visually and physically checked to confirm it is unloaded, and the action is open.



10. AVOID ALCOHOLIC BEVERAGES OR JUDGMENT/REFLEX IMPAIRING MEDICATION WHEN SHOOTING.

Do not drink and shoot. If you take medication that can impair motor reactions or judgment, do not handle a firearm while you are under the influence of the medication.



11. NEVER TRANSPORT A LOADED FIREARM.

Unload a firearm before putting it in a vehicle (chamber empty, magazine empty). Hunters and target shooters should load their firearm only at their destination, and only when they are ready to shoot. If you carry a firearm for self-protection, leaving the chamber unloaded can reduce the chance of an unintentional discharge.

12. LEAD WARNING.

Discharging firearms in poorly ventilated areas, cleaning firearms, or handling ammunition may result in exposure to lead and other substances known to cause birth defects, reproductive harm, and other serious physical injury. Have adequate ventilation at all times. Wash hands thoroughly after exposure.

WARNING: It is YOUR responsibility to know and abide by Federal, State and Local laws governing the sale, transportation and use of firearms in your area.



WARNING: This firearm has the capability of taking your life or the life of someone else! Always be extremely careful with your firearm. An accident is almost always the result of not following basic firearm safety rules.



ESPECIALLY FOR U.S. CONSUMERS:

For information about Firearm Safety Courses in your area, please visit the National Rifle Association's web site at www.nra.org.

AMMUNITION

AMMUNITION (CARTRIDGE) NOTICE: Beretta specifically disclaims responsibility for any damage or injury occurring with, or as the result of, the use of faulty, non-standard, “remanufactured,” hand-loaded or reloaded ammunition, or cartridges other than those for which the firearm was originally chambered. Serious damage or injury, even death, could result from the use of incorrect ammunition, from firing against bore obstructions and from propellant overloads. Use of improper ammunition, such as listed previously will void the manufacturer’s warranty. Use only high-quality, commercially-manufactured ammunition made in accordance with CIP (Europe and elsewhere) or SAAMI® (USA) standards. Be certain that the ammunition is the appropriate caliber and loading for the firearm and is clean, dry and in good condition. The pistol caliber is stamped on the back of the barrel, visible from the ejection port.



WARNING: Carefully inspect each cartridge before it is loaded in the magazine. Be certain the cartridge cases are not split or deformed, and that the cartridges do not possess any other dents or defects. This warning even applies to factory ammunition.

Do not fire old ammunition. Primers, powder, cartridge cases, and bullets can deteriorate with time and cause damage to the firearm, or injury to the shooter or others.



WARNING: The extended use of +P or +P+ ammunition may decrease component part service life expectancy. DO NOT use sub-machine gun ammunition because the chamber pressure may reach or exceed proof load pressure. Lead bullets have a tendency to cause bore leading, which may dramatically increase the discharge pressure. Be sure to remove all chamber and bore lead accumulation after each use. DO NOT shoot cartridges with jacketed bullets through a barrel previously fired with lead bullets before the bore is thoroughly delead.

DRY FIRING & DUMMY” ROUNDS

Dry firing is defined as firing a firearm with no ammunition in the chamber. Long term dry firing your Beretta Nano pistol may result in damage to the striker. “Snap Caps” (inert chamber inserts that allow a firearm to be dry-fired without damaging the action) are available at most gun stores for those who wish to practice firing without live ammunition.

CAUTION: “Dummy Rounds” with empty primer pockets are suitable for loading/unloading practice but **DO NOT PROTECT** the striker tip during dry firing.

LOADING

WARNING: Whenever a live round is in the chamber, this pistol can fire, even if the magazine is empty or has been removed.



WARNING: Before loading the firearm, become familiar with the following loading procedures without the use of ammunition. Never handle a loaded firearm until you are familiar with the loading procedures.



WARNING: Always keep your finger away from the trigger until you are prepared to fire.



WARNING: LOAD THE CHAMBER ONLY WHEN READY TO FIRE.



LOADING THE MAGAZINE



WARNING: Be sure that you have the correct cartridges for your pistol.

To load the magazine:

Remove it from the pistol by depressing the magazine release button.

Hold the magazine in one hand. With the other hand, place a cartridge on the magazine follower in front of the feed lips at the top of the magazine. Press the cartridge down onto the follower and slide the cartridge under the feed lips until it is seated fully inside the magazine body.

Repeat process until magazine is fully loaded. The holes on the side of the magazine allow for visual counting of cartridges.

CAUTION: Do not try to force more than the maximum number of rounds indicated for your particular pistol into the magazine. An overloaded magazine may not function properly.

LOADING THE PISTOL AND THE FIRING CHAMBER



WARNING: Beretta assumes no responsibility for any injury or property damage resulting from improper or careless handling, intentional or accidental discharge of the firearm.



WARNING: Be sure that the obstruction check has been completed prior to loading.



WARNING: Point the firearm in a safe direction. Do not touch the trigger until you are ready to fire and are sure of your target and backstop.

The firing chamber is the portion of the barrel into which the cartridge is fed. The firing chamber may be loaded in one of two ways:

I. MANUALLY LOADING FROM MAGAZINE

Completely push the loaded magazine into the pistol grip to insure magazine catch engagement. Pull back the slide and release it. The slide will automatically pick up a cartridge from the top of the magazine and feed it into the chamber

2. AS LONG AS THERE IS AMMUNITION IN THE MAGAZINE, A PISTOL WHICH IS LOADED AND FIRED, WILL AUTOMATICALLY PICK UP THE NEXT ROUND AND FEED IT INTO THE FIRING CHAMBER.

To replace a round which has been chambered from the magazine; (remember that you are handling a loaded firearm with a live round in the chamber):

Make sure your finger is not on the trigger or inside the trigger guard
Remove the magazine from the pistol by depressing the magazine release button.

Insert one more cartridge into the magazine.

Completely push the loaded magazine into the pistol grip to insure magazine catch engagement.

WARNING: THE FIREARM YOU ARE HANDLING AT THIS POINT IS LOADED WITH A LIVE ROUND IN THE CHAMBER. Keep your finger away from the trigger whenever you do not intend to fire.



UNLOADING

WARNING: Always unload the firearm whenever you do not intend to shoot.



WARNING: Be certain the pistol is pointed in a SAFE direction. Keep your finger away from the trigger.



Keeping the firearm pointed in a safe direction and fingers away from the trigger, remove the loaded magazine from the frame. Always using

safety precautions grasp the slide serrations with thumb and index finger and fully retract the slide to remove the chambered cartridge.



WARNING: Always visually inspect the firing chamber to ensure that it is empty. The chamber is empty when no cartridge is visible when looking from the ejection port into the open chamber



WARNING: If you are ejecting unfired cartridges, use extreme care to be sure they are ejected onto an appropriate surface. Never attempt to catch cartridges or fired cartridge cases as they fall.



WARNING: Never allow anything to come in contact with the primer of unfired ammunition. Doing so could cause the ammunition to explode.

When sure that the chamber is empty and the cartridge has been ejected, release the slide.



WARNING: Releasing the fully retracted slide when a loaded magazine is in the pistol will feed a cartridge into the pistol's firing chamber and the pistol will be able to fire immediately.

NOTE: It is recommended to store the firearm unloaded, slide closed, with the magazine empty.

UNLOADING THE MAGAZINE

To unload the magazine:

Grasp the magazine with one hand around the magazine box, bottom down and front end forward.

With the tip of the thumb firmly press down on the cartridge rim and push towards the front of magazine box.

As the cartridge moves forward, tip it slightly upward with the index finger.

Repeat until the magazine is unloaded.

FIRING

WARNING: Beretta assumes no responsibility for any injury or property damage resulting from improper or careless handling, intentional or accidental discharge of the firearm.



WARNING: Be certain the firearm is pointed in a SAFE direction. Never put your finger on the trigger unless you intend to shoot.



WARNING: High-quality eye and ear protection should be worn by all present when firing any firearm.



To fire the pistol, insert the magazine into the pistol and the round into the firing chamber by following the "LOADING" instructions, (pages 13-15).

Without placing the finger on the trigger or inside the trigger guard, point the pistol at the intended target. Aim the pistol by aligning the front sight in the notch of the rear sight. Point the front sight at 6 o'clock in the center of the target. The front sight should be in focus, the target and the rear sight slightly blurred or out of focus.

WHEN YOU ARE READY TO FIRE:

WARNING: THE PISTOL IS NOW READY TO FIRE.



Place your index finger inside the trigger guard.

WARNING: Ensure that fingers or other parts of the hands and the face are kept away from the slide. Not respecting this warning can lead to serious injury. During the firing cycle, the slide moves to the rear violently and with great energy. Ensure that the other hand is kept away from the muzzle of the barrel.



Gently squeeze the trigger, being careful not to upset the alignment of the front and rear sights. THE PISTOL WILL FIRE. The discharge will force the slide and barrel to the rear, which will in turn eject the fired cartridge case, reset the stiker and compress the recoil spring. Then the slide will close, feeding the next cartridge from the magazine into the chamber.



WARNING: THE PISTOL IS STILL LOADED, COCKED AND READY TO FIRE. Keep your finger away from the trigger whenever you do not intend to fire.

When the last round has been fired the slide will remain open.

To fire again, remove the empty magazine and insert a loaded one. Pull the slide to the rear and release it to close the slide and load the chamber.

When you have completed shooting, remove the magazine, check that the firing chamber is empty, see "UNLOADING" (pages 15-17) and close the slide by pulling the slide to the rear to release the slide lock.



WARNING: Always unload the firearm immediately after shooting is completed. Never store a loaded firearm. To store the pistol see the paragraph "STORAGE" (page 51).



WARNING: If while firing the trigger is pulled and the firearm does not immediately fire: CEASE FIRING IMMEDIATELY and do the following:

Keep the firearm pointed in a SAFE direction in the event a "hang-fire" has occurred. A hang-fire occurs when there is a delay in a cartridge's ignition.

With the pistol pointed in a SAFE direction, wait one (1) full minute. After one (1) full minute has elapsed, completely unload the firearm by following the "UNLOADING" instructions in this manual (pages 15-17).

Carefully inspect your ammunition. Immediately refer to a qualified gunsmith if the striker indent on a fired cartridge's primer is light, off-center or does not exist. Following the "FIELD STRIPPING" instructions, (pages 28-30), field strip the pistol and look down the barrel to make sure that no obstruction exists. If a barrel obstruction is detected, a qualified gunsmith must remove the obstruction and inspect the pistol before it can be fired.

WARNING: If another cartridge is fired into an obstructed barrel, catastrophic failure can result.



WARNING: If, while firing, you hear a change in the sound of a fired cartridge, or feel a change in the amount of recoil, or detect any other irregularity, CEASE FIRING IMMEDIATELY and do the following:



Keep the firearm pointed in a SAFE direction. A "squib load" may have occurred. A "squib" occurs when a cartridge fires, but with insufficient force to drive the bullet out of the barrel. This can result in a dangerous bore obstruction.

With the gun pointed in a SAFE direction, completely unload the firearm by following the 'UNLOADING' (pages 15-17). Following the "FIELD STRIPPING" instructions (pages 28-30), field strip the pistol and look down the barrel to make sure that no obstruction exists.

WARNING: Never attempt to reuse or fire ammunition that did not fire the first time. Dispose of unfired or damaged ammunition properly, per the ammunition manufacturer's recommendation.



DESCRIPTION

The Beretta Nano is the ultimate evolution of the micro compact carry pistol. Utilizing a removable, serialized sub-chassis the Nano pistol can be easily modified with replaceable grip frames and is simple to disassemble and maintain. Ease of use and concealment were key drivers in the development of the Nano. The Nano's extremely low profile, snag free design makes it easy to carry and draw from concealment. To accommodate right or left-handed use, the Nano's magazine release button can be easily reversed. The light, durable, frame employs modern thermoplastic technology through the use of fiberglass reinforced technopolymer. The Nano's sights are user adjustable with a 1.3mm hexwrench and your fingers. This allows anyone to adjust their sights without the assistance of a gunsmith. Modular structure, ergonomics and ease of use make the Beretta Nano the ideal firearm for concealed carry.

SAFETY FEATURES

Striker Deactivation Button

Beretta Nano pistols have a unique feature that allows the user to deactivate the internal striker mechanism prior to disassembly. This means the pistol can be disassembled **WITHOUT PULLING THE TRIGGER.**



Automatic striker block safety

Beretta Nano pistols have a striker blocking device that prevents forward movement of the striker unless the trigger is completely pulled.



Trigger Drop Safety

The Trigger Drop Safety stops the trigger from traveling rearward through inertia, in the event the pistol is dropped. When the trigger is intentionally pulled, the Trigger Drop Safety is instantly deactivated.



Slide catch

The slide catch is a lever that holds the slide open after the last round is fired. This allows the user to immediately determine that the pistol does not have a round in the chamber or in the magazine. The Nano's slide catch is internal and completely snag free.



OPERATIONAL FEATURES

Semiautomatic firing

Beretta Nano pistols will automatically reload after each round is fired, as long as there are cartridges in the magazine.

Barrel locking system

The barrel and slide are locked together as a unit at the time of discharge. As they move to the rear during recoil, the barrel cam operates on the disconnect pin causing the barrel to disengage from the slide and allows the slide to continue its rearward travel.

Striker Fired Trigger System

When the trigger is pulled the trigger bar rotates the cocking lever to the rear, the cocking lever pushes the striker against the striker spring. Just before full trigger travel is reached, the cocking lever pushes the striker block out of engagement and releases the striker. The striker travels fully forward under inertia. After the striker reaches its full forward position the striker return spring rebounds the striker to a neutral position so the striker block is automatically activated when the trigger is released.

Magazine

The Beretta Nano pistol has an easily removable, single column magazine that allows for rapid reloading of the pistol. The 9mm x 19 Parabellum (or Luger), 9mm x21 IMI and .40 S&W magazine capacities are 6 rounds.

WARNING: In order to permit the use of the pistol in emergency situations, even in the case of involuntary dropping or loss of the magazine, this model is NOT provided with a magazine disconnect safety. It is, therefore, capable of firing any time a round is chambered.



Interchangeable, Low Profile sights

The high definition 3-dot sight system is designed for quick target acquisition. Rear and front sights can be removed for replacement with other types of sights.

CAUTION: When tightening the set screws that hold the sights, grasp the hex wrench by the short end to avoid over tightening and stripping the hex driver out of the set screws.



ERGONOMIC AND MODULAR FEATURES

Technopolymer grip frame

By using corrosion-resistant fiberglass reinforced technopolymer, Beretta has developed a light and technically advanced pistol with an ergonomic shape. The rounded, snag free surfaces of the pistol ensure trouble-free holster insertion and extraction.

Ergonomic and modular grip

The ergonomic frame features an optimal grip angle for sight alignment and target acquisition. The upper rear part of the grip is contoured to snugly fit and protect the shooter's hand. Both the front and the rear grip surfaces feature a comfortable checkered surface to ensure a firm hold.

Reversible magazine release button

The magazine release button can be installed for right- or left-hand use depending on shooter preference (pages 34-37).

Snag free internal slide catch

The snag free slide catch is activated by the magazine follower. To hold the slide to the rear it is necessary to insert an empty magazine before retracting the slide. To lower the slide on an empty chamber, remove the empty magazine, pull back slightly on the slide to disengage the slide catch and release the slide.

Interchangeable grip frame and serialized sub-chassis

The internal chassis of this pistol is the only serialized part. This allows any other component to be exchanged or customized without affecting the serialized part.



WARNING: Do not attempt to alter your pistol's firing mechanism. Modifying these internal parts can cause an unsafe condition.



WARNING: Altering the internal parts of your pistol's firing mechanism voids the manufacturer's warranty.

Field stripping, cleaning and re-assembly

The pistol is designed for quick and simple field stripping and to avoid unintentional disassembly. Reassembly is easy and intuitive. Improper assembly of parts is prevented by the distinctive design.

SPECIFICATIONS AND TECHNICAL DATA

Model: Nano

Caliber: 9x19 (Parabellum or Luger), 9x21 IMI or .40 S&W

Magazine Capacity: 6 rounds

Rifling Pitch: 15.75 in/ 400 mm (9mm), 10 in/ 250 mm (.40 S&W)

Rifling: R.H. – 6 Grooves

General Operation: Semiautomatic, short recoil system

Locking System: Cam operated, tilt-barrel, locked breech

Sights: Removable front and rear sights

Frame/Chassis: Stainless steel

Grip Frame: Fiberglass reinforced technopolymer

Slide: Steel with a black Nitride finish

Barrel: Steel with a black Nitride finish

Action: Striker Fired

Safety: Automatic striker block and trigger drop safety

Overall Length: 5.63 in/ 143 mm

Barrel Length: 3.07 in/ 78 mm

Overall Width: .90 in / 23 mm

Grip Width: .90 in/ 23 mm

Overall Height: 4.17 in/ 106 mm

Sight Radius: 4.92 in/ 125 mm

Approximate weight unloaded: 20oz/ 562 grams with empty magazine

GENERAL OPERATION

The Beretta Nano pistol is a semiautomatic firearm using a cam operated, tilt-barrel, locking system. When the pistol is fired, the recoil energy causes the barrel and slide assembly to move to the rear. After a short distance, the barrel is forced down and is stopped by the operation of the barrel cam and disconnect pin interface. The slide continues its rearward travel under inertia, extracting the fired case from the barrel and ejecting it through the ejection port. The recoil spring pushes the slide forward, feeding the next cartridge from the magazine into the barrel chamber. Continued forward movement causes the barrel cam to raise the barrel into its locked position in the slide and engage the striker with the cocking lever. The slide is designed to remain open after the last cartridge has been fired and the spent shell casing ejected.

LOAD CHECK



WARNING: Keep your finger OFF OF THE TRIGGER and the barrel pointed in a SAFE direction when checking to be certain your Nano pistol is unloaded.

To visually check to be certain your pistol is unloaded carefully follow the steps below.

Remove the magazine by depressing the magazine release button. Retract the slide and visually inspect the cartridge chamber. The pistol is unloaded when no cartridge is visible when looking into the open chamber.



For safety, you should...

Always visually check to see that the chamber is unloaded. Never assume that a firearm is unloaded (even with a gun that is new and in its original packaging).

Never point a firearm toward yourself or another person.

Lock the slide in the open position and remove the magazine before handing the pistol to another person.

Never take any pistol from another person unless the slide has been locked open, the magazine has been removed and the chamber has been visually checked to confirm it is unloaded.

LOCKING THE SLIDE OPEN



WARNING: Keep your finger OFF OF THE TRIGGER and the barrel pointed in a SAFE direction.



WARNING: Always keep your finger away from the ejection port.

Locking the slide in the open position requires an empty magazine to first be inserted.

NOTICE: The slide will release when pulled to the rear if a **LOADED** magazine is inserted.

NOTICE: The slide will release when pulled to the rear if **NO** magazine is inserted.

To lock the slide in the open position:

Remove the magazine by depressing the magazine release button. Retract the slide to ensure the chamber is empty. Fully insert an **EMPTY** magazine. Retract the slide to the rearward most position. The slide will lock open.

NOTICE: The slide will remain locked in the open position when the magazine is removed.

FIELD STRIPPING



WARNING: Make sure the pistol is unloaded. If not, unload it following the “UNLOADING” instructions in this manual (pages 15-17).

NOTICE: It is advisable to perform field stripping and assembly operations over a table to catch components should they drop.

Remove the magazine and ensure the pistol is unloaded by inspecting the barrel's chamber.

Depress the Striker Deactivation Button with a small punch or the tip of a ballpoint pen.



Rotate the Disassembly Pin approximately $\frac{1}{4}$ turn counterclockwise to disengage the Pin from the barrel.



Move the slide forward and remove it from the frame.



The recoil spring assembly can now be lifted out of the slide.



Tilt the barrel by grasping the cam lug and remove the barrel from the slide.



NOTICE: No further disassembly is required for routine maintenance.

REASSEMBLY

Reassemble by inserting the barrel into the slide. Tip the barrel to install the muzzle end through the hole in the front of the slide, then lower the rear end into position in the slide.



Install the recoil spring assembly with the large flat end engaged into the recess in the barrel cam lug.



Notice: If the slide is released when under spring pressure and the Disassembly Pin is not in the “Locked” position, the slide can launch off the frame.

Check that the disassembly pin has the flat side up and install the slide assembly on the frame.



Pin shown in unlocked position.

With the muzzle pointed in a safe direction, slowly retract the slide and visually confirm that the Disassembly Pin has returned to the “Locked” position.



BARREL OBSTRUCTIONS CHECK

WARNING: Catastrophic failure can result if a cartridge is fired into an obstructed barrel.



If you believe the barrel might be obstructed follow the "FIELD STRIPPING" operations and disassemble the pistol (pages 28-30).

After disassembly, look down the barrel and check to be sure there are no obstructions in the chamber or bore.

If an obstruction in the barrel is detected, a qualified gunsmith **MUST** remove the obstruction and inspect the pistol to ensure it is safe before it can be fired.

If no obstruction is found, reassemble the pistol by following the procedures given in the "REASSEMBLY" section of this manual (pages 31-32).

REPLACING THE MAGAZINE RELEASE BUTTON



WARNING: Make sure the pistol is unloaded. If not, unload it following the “UNLOADING” procedure (pages 15-17).

CAUTION: Before proceeding with the disassembly of the parts, closely observe and memorize the position of the components to make assembly easier.

NOTICE: It is advisable to perform field stripping and assembly operations over a table to catch components should they drop.

Remove the magazine. Insert a properly sized drift-punch into the hole of the magazine release button mounted on the pistol.

Without using excessive force, firmly push, the drift-punch into the hole. This will allow the magazine release button to disengage from the internal pin, which will protrude from the opposite side.



Remove the pin from the magazine catch, then remove the button from its seat.

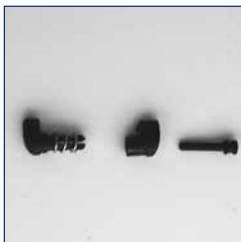
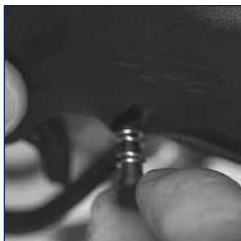

Place the magazine catch in the seat, place the magazine button in the other seat. Depress magazine button to its full travel. Insert magazine button pin into the magazine catch. Firmly push on the head of the magazine button pin so that it will lock the assembly together.

Try to remove the button from its seat to check that it is properly installed.



Check that the magazine release button functions correctly with an empty magazine inserted into the grip.

REVERSING THE MAGAZINE RELEASE BUTTON

WARNING: Make sure the pistol is unloaded. If not, unload it following the “UNLOADING” procedure (pages 15-17).



CAUTION: Before proceeding with the disassembly of the components, closely observe and memorize the location of the components to make assembly easier.

NOTICE: It is advisable to perform disassembly and assembly operations over a table to catch components should they drop.

Remove the magazine.

Follow the instructions previously given to remove the magazine release button (pages 34-36).

CAUTION: The spring is under tension.

Reassemble the magazine button with its spring on the opposite side of the pistol.

Try to remove the button from its seat to check that it is assembled properly.

Check that the magazine release button functions correctly with an empty magazine inserted into the grip.

GRIP FRAME REMOVAL

Beretta Nano pistols have a sub-chassis that carries the serial number and firing mechanism. The grip frame can easily be removed for maintenance or to be replaced with an alternate unit.

To remove the Grip Frame:



WARNING: Make sure the pistol is unloaded. If not, unload it following the "UNLOADING" instructions in this manual (pages 15-17).



Step 1

Field strip the pistol following the "FIELD STRIPPING" instructions in this manual to remove the slide assembly (pages 28-30).



Step 2

Push the Disassembly pin out from left to right and place it aside.



Step 3

With a small punch, lift the bent leg of the Cocking Lever Spring out of the retaining groove in the Rear Assembly Pin and let the leg of the spring rest on the pin.

With the same punch, push the Rear Assembly Pin out of the frame from right to left and place it aside.



NOTE: Read this step completely before proceeding.

When attempting to lift the chassis out of the grip frame, depress the Striker Deactivation Button with a small punch or the tip of a ballpoint pen. When the tips of the pin clear the inner walls of the frame the chassis will lift out. Slowly raise the rear of the chassis just enough to pinch the trigger bar (on the right) and the slide catch (on the left) to the sides of the chassis and lift the assembly out of the frame and set it aside. The trigger bar and slide catch will be loose and may fall away. Before setting the grip frame down, carefully remove the slide catch spring from its recess on the left side of the frame, and place it aside.



CAUTION: If the chassis is pulled out quickly the Trigger Bar, Slide Catch, and Recoil Spring Support may fall away from the chassis. The Slide Catch Spring may also fall out of the frame and if the chassis is rotated the Disconnect Pin and Trigger Pin will slide out of their holes.





CAUTION: No further disassembly is recommended unless done by a competent gunsmith.

GRIP FRAME / CHASSIS ASSEMBLY

NOTE: Read this section completely before proceeding.

Insert the trigger and spring assembly into the chassis. Slide the loop of the trigger spring over the lip of the chassis as shown below.

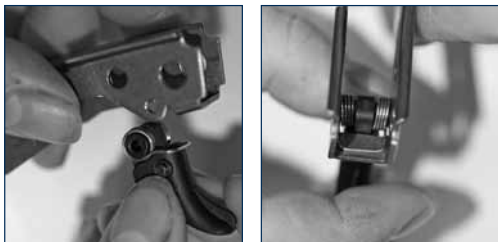

Insert the trigger pin through the chassis and trigger assembly.



Place the recoil spring support in the bottom of the Chassis over the Trigger Spring.



Place the trigger bar on the trigger bar pin with the tip under the Striker Deactivation Button.



Pinch the Trigger Bar to the Chassis and plug the Trigger Pin hole and Disconnect Pin hole with finger tips as shown.



Insert the Disconnect Pin with the small end to the left.



Place Slide Catch on the Disconnect pin and pinch entire assembly together.



While holding the assembled Chassis, support the Frame in the same hand and install the Slide Catch Spring in the Frame.



Install the assembled chassis in the Frame starting with the front corner and roll the rear of the chassis down until the Striker Deactivation Button contacts the top of the Frame.



NOTE: Make sure the left-end of the Striker Deactivation Button is in its hole. When correct, the rear gap in the chassis will be closed as shown below.



While lightly pressing down on the chassis assembly, depress the Striker Deactivation Button with a punch until the chassis drops into the frame. (See above image on right.) There will be an audible “snap” when the chassis is seated.

Press the Disassembly Pin through the Frame and Chassis from right to left. It may be necessary to rotate the pin back and forth to seat the o-ring and Disassembly Pin and orient the Disassembly Pin with the flat side up.



Using the punch, lift the hooked end of the cocking lever spring higher than the Rear Assembly Pin hole, and install the Rear Assembly pin from left to right. The small end enters the hole first. Using the punch seat the hooked end of the Cocking Lever Spring into the groove on the Rear Assembly pin.



This completes the grip frame reassembly.

MAINTENANCE

The firearm should be cleaned as soon as possible after firing. Use only high-quality, commercially available firearm cleaning solvents, gun oil and cleaning equipment. Field strip the pistol as indicated in the “FIELD STRIPPING” section of this manual (pages 28-30).

WARNING: Excess oil and grease obstructing the bore, even partially, is very dangerous when firing and may cause barrel rupture and serious injury to the shooter and bystanders. Never spray or apply oil to the cartridges. Use lubricants properly. You are responsible for the proper care and maintenance of your firearm.



BARREL

Apply gun oil to a bore-cleaning brush. Insert the brush into the barrel from the chamber end and scrub the chamber and bore thoroughly. Make sure you pass the bore brush all the way through the barrel before pulling back through. If necessary, first clean the bore with a gun solvent. Dry the chamber and bore by pushing a cotton patch through the chamber and bore with the brush or cleaning jag. Repeat with a new patch until it emerges clean. Clean the barrel locking lug with a cloth soaked in gun oil. Lightly oil the entire barrel prior to reassembly.

CAUTION: Do not clean the barrel with the pistol assembled.

NOTICE: Cleaning the barrel from the breech (chamber) end will avoid damaging the muzzle or bore.

SLIDE

Clean the slide with a cloth soaked in gun oil paying particular attention to the breech face, extractor, slide rails, locking shoulders. If necessary, use a NYLON cleaning brush. Dry slide surfaces with a clean cloth and lightly oil the slide.

RECOIL SPRING AND SPRING GUIDE ASSEMBLY

Lightly oil the spring guide assembly with gun oil. After extensive use it may be necessary to first clean these parts using a NYLON cleaning brush.

FRAME

Using a cloth lightly soaked in gun oil, clean the areas of the cocking lever, the ejector, and the slide rails. If necessary, use a cleaning brush. Dry the parts and lightly oil the slide rails.

MAGAZINE

Make sure the magazine is thoroughly clean and that the follower slides easily downward if pressed. Dry the internal walls of the magazine box with a cloth. Do not leave any oil in the magazine.

CAUTION: Do not apply excess oil. Accumulation of oil attracts dirt and dust, which can interfere with the functioning and reliability of the firearm.

STORAGE



WARNING: Always store the pistol UNLOADED, with the magazine empty.



WARNING: Always store your firearm so that children can not gain access to it. To reduce the risk of accidents involving children, unload your firearm, lock it and store the ammunition in a separate locked location.

CAUTION: Before storage, always check the conditions of the pistol and its case. Make sure the case is dry and that the firearm is dry and oiled. Traces of moisture or drops of water could damage the pistol.

Addendum:

During pistol disassembly, should the spacer on the captive recoil spring become misaligned as shown in figure 1, follow the instructions below to realign it.

Figure 1



Compress the spring with your fingers as shown in figure 2.

Figure 2



Realign the spacer at top to its correct position as shown in figure 3.

Figure 3



TROUBLESHOOTING



WARNING: Do not attempt to make repairs to any firearm without proper knowledge or training. Do not alter parts or use substitute parts not made by Beretta. Any necessary alterations or adjustments to the operating mechanism should be performed by the Manufacturer or by its Local Official Distributor.



WARNING: Do not attempt to alter the internal parts of your pistol's firing mechanism. Altering internal parts can cause unsafe condition.



WARNING: Altering the internal parts of your pistol's firing mechanism voids the manufacturer's warranty.

MALFUNCTION	PROBABLE CAUSE	REMEDY
Mis-introduction of a cartridge into the chamber	Defective cartridge	Inspect and replace cartridge
Mis-fire	Defective cartridge	Replace cartridge
Mis-extraction or defective extraction	Dirty cartridge chamber	Clean cartridge chamber
	Defective or dirty ammunition	Replace or clean cartridges
	Dirt under the extractor	Clean the extractor seat

SERIAL NUMBER: _____

DATE PURCHASED: _____

PURCHASE PRICE: _____

DEALER INFORMATION: _____

The illustrations and descriptions given in this brochure are intended as a general guide only, and must not be taken as binding. The Company, therefore, reserves the right to make, at any moment and without prior notice, any changes it thinks necessary to improve its models or to meet any requirements of manufacturing or commercial nature.

Beretta USA Corp.

17601 Beretta Drive

Accokeek, MD 20607

1-800-Beretta

www.berettausa.com

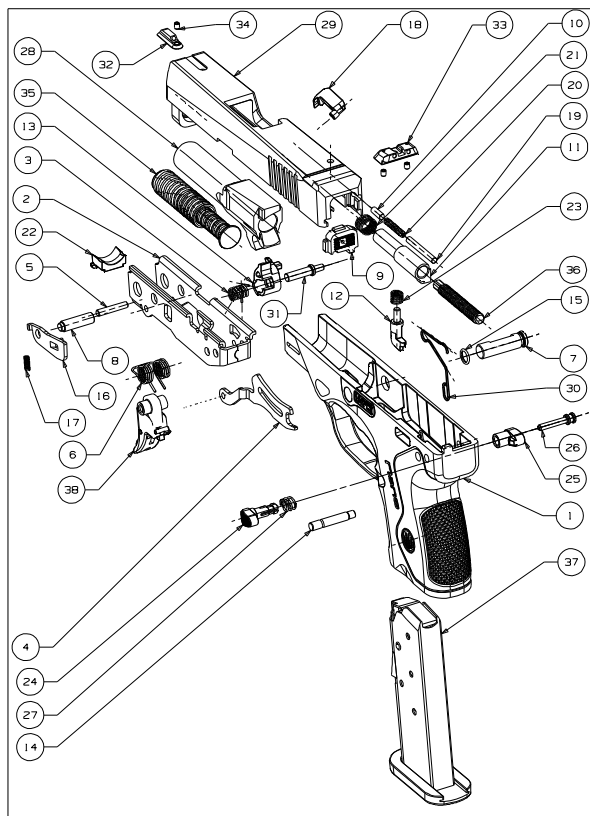

38	UD7A0298	TRIGGER ASM	1
37	UD8A0324	MAGAZINE	1
36	UD7A0290	STRIKER SPRING ASM	1
35	UD7A0285	RECOIL SPING ASM	1
34	UD5A1043	SET SCREW 2.5MMX3LG	3
33	UD5A1042	REAR SIGHT	1
32	UD5A1041	FRONT SIGHT	1
31	UD5A1036	COCKING LEVER PIN	1
30	UD5A1033	TRIGGER BAR SPRING	1
29	UD5A1010	SLIDE, .40	1
28	UD5A1009	BARREL, 9MM	1
27	UD5A1002	MAGAZINE CATCH SPRING	1
26	UD5A1001	MAGAZINE BUTTON PIN	1
25	UD5A0999	MAGAZINE BUTTON HOUSING	1
24	UD5A0998	MAGAZINE BUTTON	1
23	UD5A0988	STRIKER BLOCK SPRING	1
22	UD5A0966	RECOIL SPRING SUPPORT	1
21	UD5A0954	STRIKER RETURN SPRING	1
20	UD5A0953	EXTRACTOR SPRING	1
19	UD5A0952	EXTRACTOR PIN	1
18	UD5A0951	EXTRACTOR	1
17	UD5A0942	SLIDE CATCH SPRING	1
16	UD5A0941	SLIDE CATCH	1
15	UD5A0938	O-RING	1
14	UD5A0937	REAR ASSEMBLY PIN	1
13	UD5A0930	COCKING LEVER	1
12	UD5A0926	STRIKER BLOCK	1
11	UD5A0925	STRIKER	1
10	UD5A0924	EXTRACTOR PLUNGER	1
9	UD5A0923	SLIDE BACK	1
8	UD5A0922	DISCONNECT PIN	1
7	UD5A0921	DISASSEMBLY PIN	1
6	UD5A0920	TRIGGER SPRING	1
5	UD5A0919	TRIGGER PIN	1
4	UD5A0916	TRIGGER BAR	1
3	UD5A0915	COCKING LEVER SPRING	1
2	UD5A0911	RAIL CHASSIS	1
1	UD5A0910	FRAME	1
PC NO	PART NUMBER	PART NAME	QTY



BERETTA

500 YEARS. ONE PASSION.

Beretta USA Corp.
17601 Beretta Drive
Accokeek, MD 20607
Tel. (301) 283-2191
www.berettausa.com